

Manual Antenna Tuner package instructions

Days can tune to the original non-resonant antenna by adding the appropriate inductance or capacitance so that the radio can work properly. The original resonant antenna, the antenna has changed due to outside influences, the SWR can be amended. Can be used as a band-pass filter, the emission can reduce unnecessary radiation outside the band, the cross-modulation and interference-band receiver can be reduced again.

Days tune kit comes with the standing wave directions, using a T-type topology network, shortwave 1-30MHz, can withstand the transmit power of 15W, the tuning range of approximately 40-300 ohms, can be very convenient for QRP communication, to ensure high efficiency radio transceiver in communication, but also allows you to fully enjoy the fun of DIY.

This kit includes the original as follows:

- A waterproof sealed box
- Stickers (used to determine the position of the transfer hole) 1
- Q9 Block (lug) 2
- Ordinary wire segment
- Variable capacitor 2
- 2 small knob
- 0.25 countersunk head screws (for fixed variable capacitor) 4
- The 0.25 head screws 2
- 0.3 gasket 4
- 0.3 nut 2
- Multi-knife switch (12 stalls) a
- A large knob
- T106-2 the toroid (red) 1
- 0.5 enameled wire, Section 1,
- A circuit board (standing wave indicator)
- A stall switch
- The red light emitting diode 1
- 51 ohm 2W resistor 3
- FT37-43 toroid (Black) 1
- 1K resistor (light-emitting diode current limit) a
- 1N60 1
- 0.1u capacitor 1

Schematic

Check out this chart carefully before hands-on production.

1, the following circuit diagram the two magnetic labels are wound in the figure.

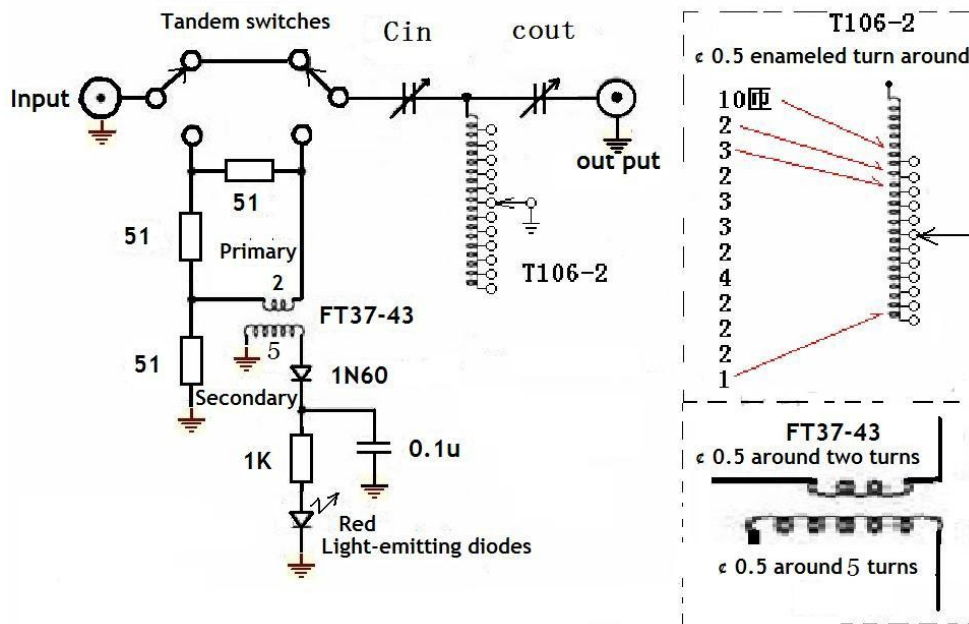

Production process

1, before making ready soldering iron, solder wire, scissors, knives, drills, wires and so on. The following picture shows the package contained in the device.

2, stickers, opening stickers holes. Careful attention to the variable capacitor holes.



3, welding standing wave detection circuit and light-emitting diodes and toggle switches installed

This operation is the first production of finished F37-43 transformer. FT37-43 and other standing wave detection device soldered in a toggle switch on the panel, note volume without soldering too much!

After soldering, the effect is as follows strict reference schematic and wiring diagram produced.

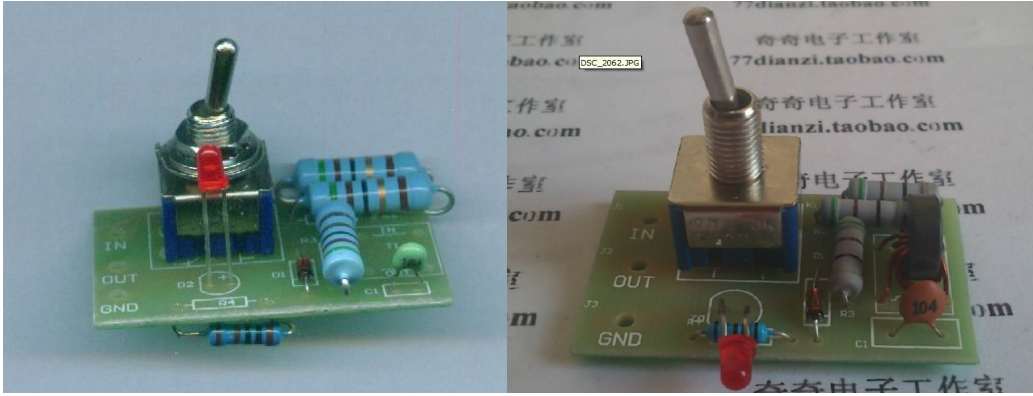

4, installation of variable capacitors and multi-knife switch. As shown below to prepare materials, installed as shown below



Rear view is as follows:

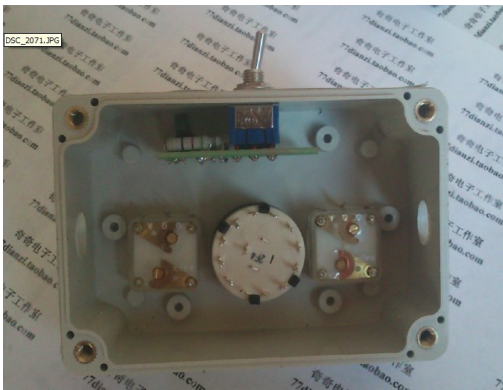

5, welding multi-tool switch

The first step, the production of inductors, to complete the effect

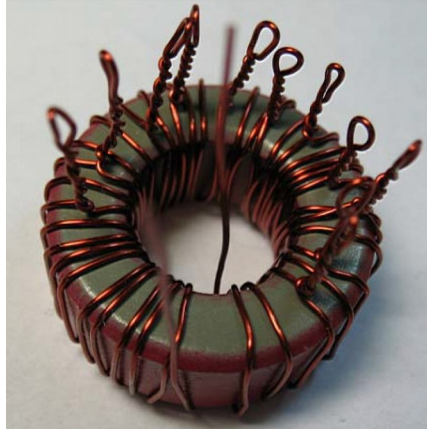
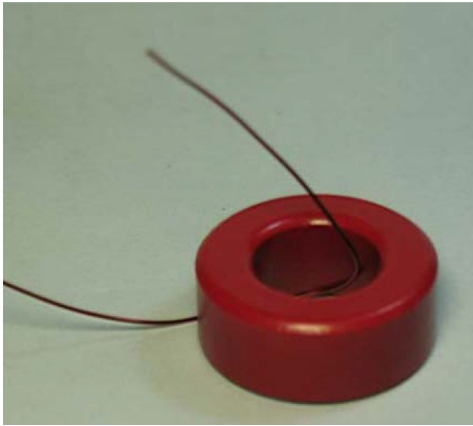

Pay attention to the winding direction and turns, maintain and schematic! Remove the knife switch, complete and inductance of the welding, the effect is as follows, the details of the plan

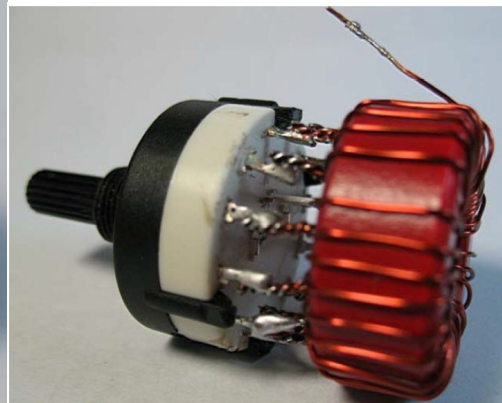

The combination of a good knife switch and inductor into the panel.

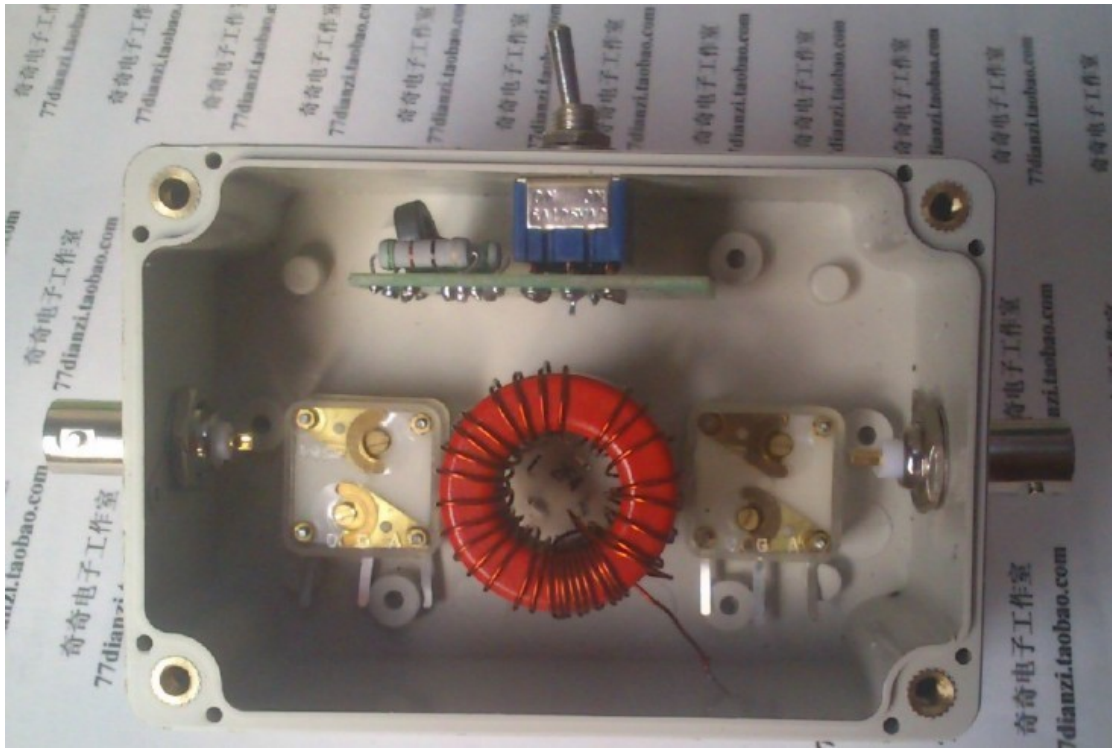

6 installation capacitance knob





7, wiring assembly, in accordance with the principles of wiring, refer to the diagram

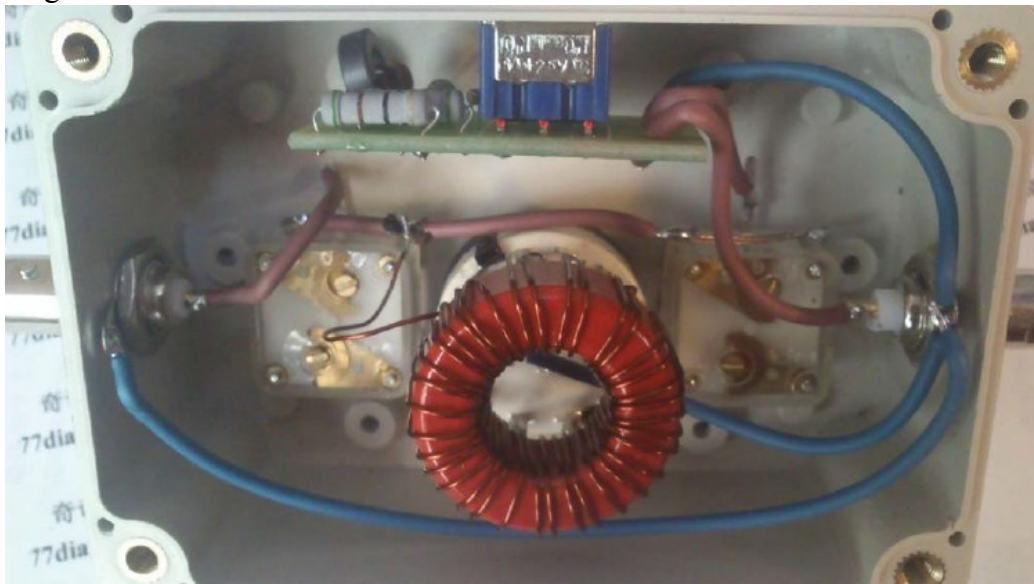

Positive effects



How to use:

1 Key allocated to the standing wave test, connected to the transmitter and antenna.

2 according to key the transmitter (SSB machine to make a call), repeated to adjust inductance knob and two capacitors knob, until the red LED brightness minimum stop tuning.

3 Key allocated to the normal use, to complete the tuning of the antenna. (Kit built-in dummy load VSWR test the maximum input power of 5W, not long to launch)

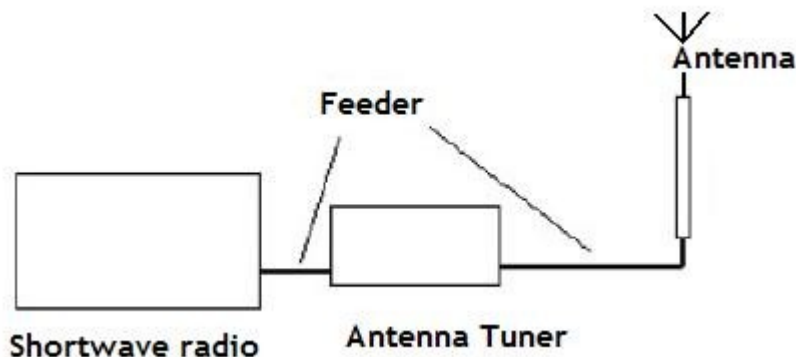

Note:

1 adjusting the tuning range of about 40-300 ohms, other parameters, if necessary, change the number of turns of T106-2 to adjust.

2 Standing wave test, the input power tune Do not exceed 5W, not a long test.

